

REMATES

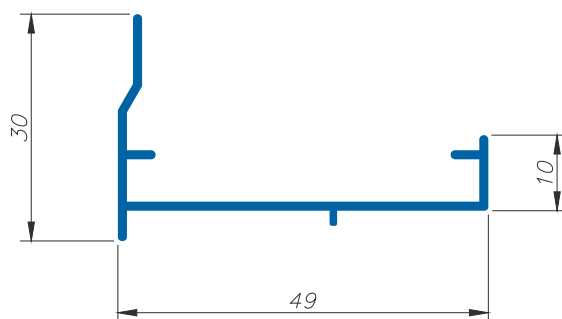

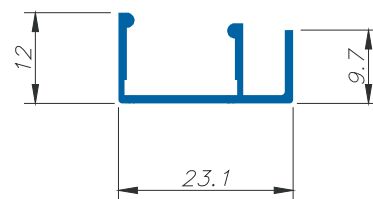

Y-206 (CM-004)
0,327 Kg/m

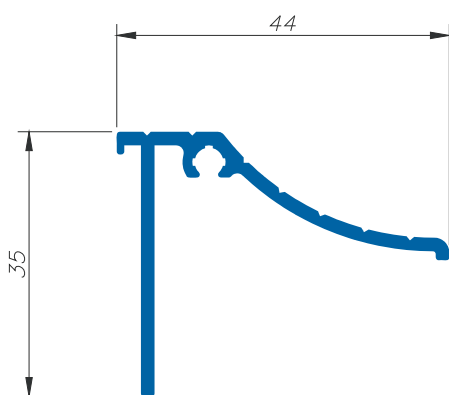
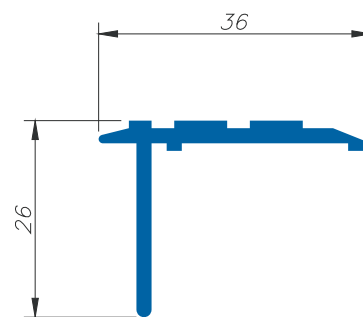
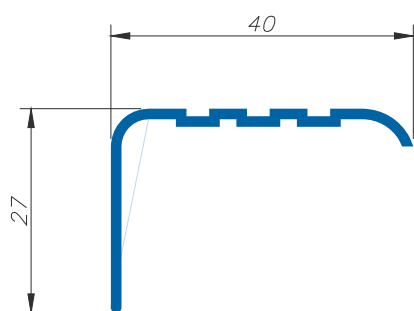
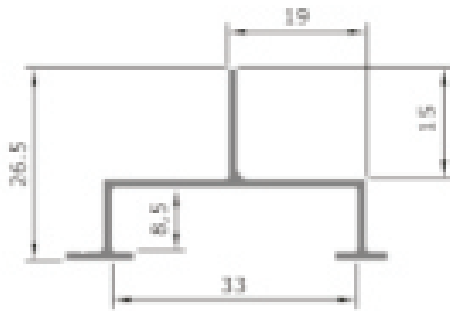
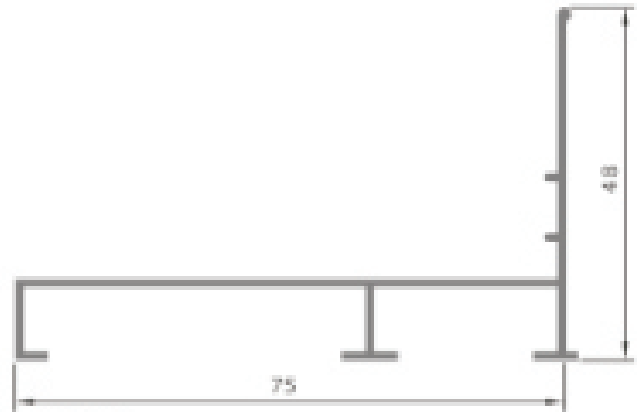

Y-709
0,520 Kg/m

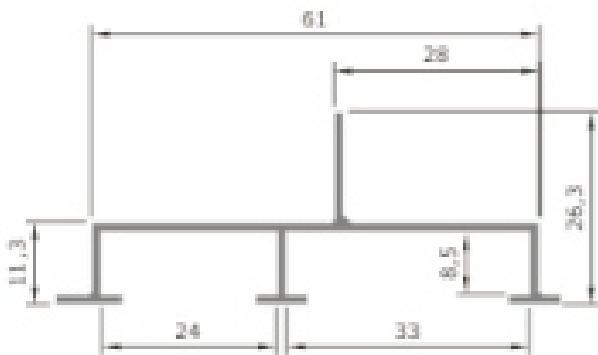

E-494 (CM-126)
0,477 Kg/m

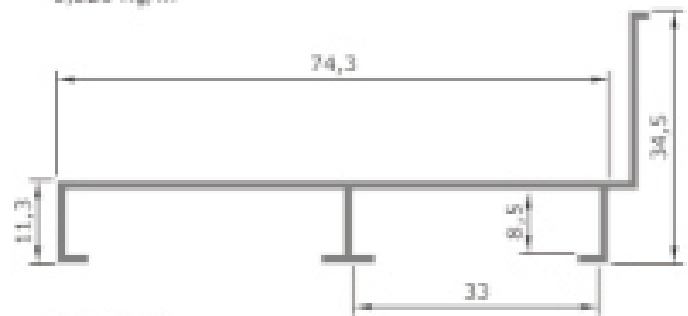

E-496 (CM-028)
0,554 Kg/m

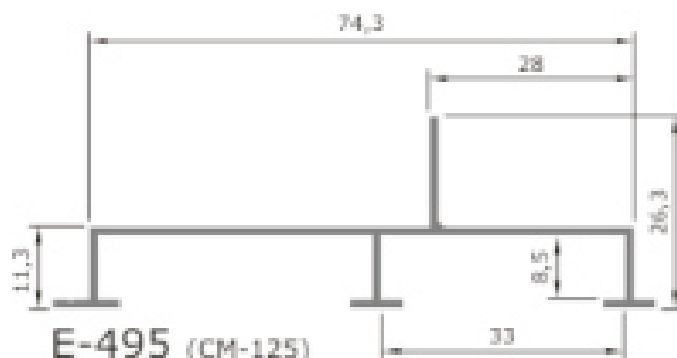

E-495 (CM-125)
0,531 Kg/m

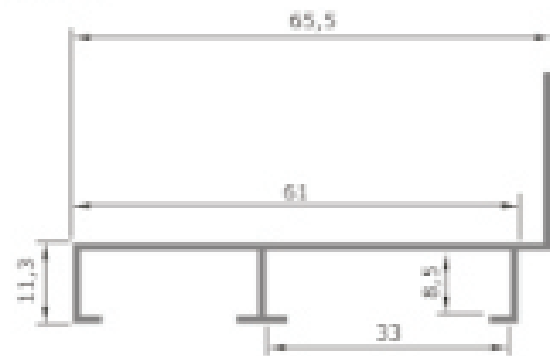

Y-715 (CM-129)
0,493 Kg/m

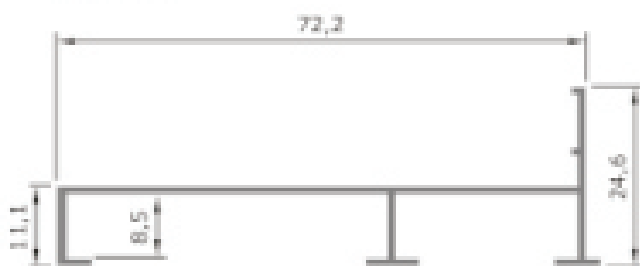

Y-687 (CM-113)
0,468 Kg/m

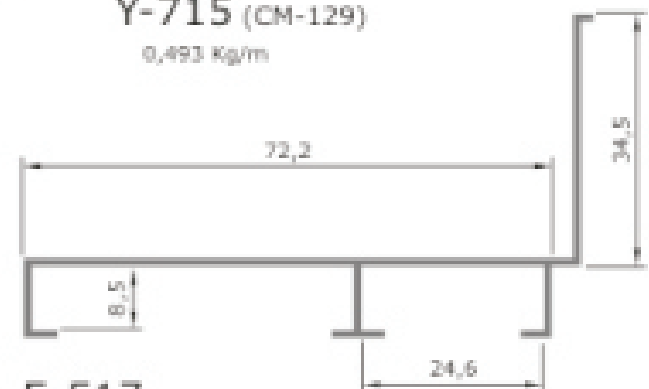

E-517
0,531 Kg/m

CONTRA MARCOS

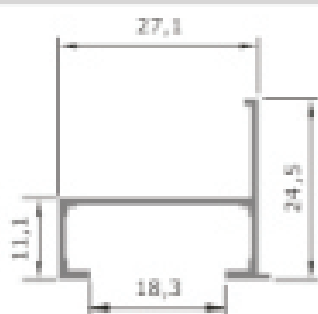

Y-721 (CM-110)

0,203 Kg/m

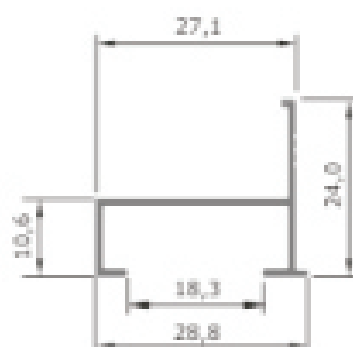

Y-721A

0,188 Kg/m

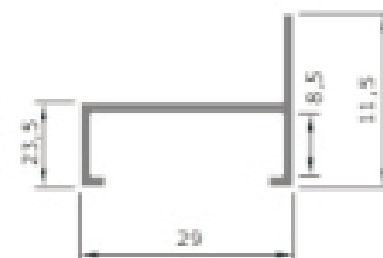

Y-120 (25-557)

0,263 Kg/m

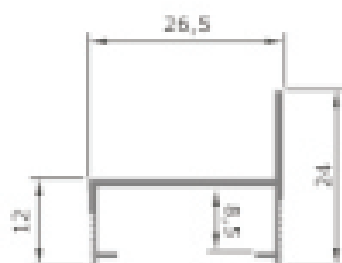

CM-063

0,230 Kg/m

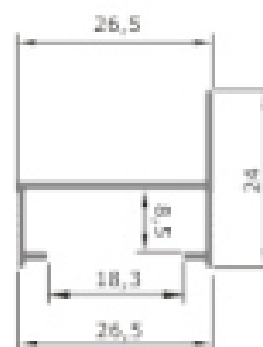

CM-063A

0,175 Kg/m

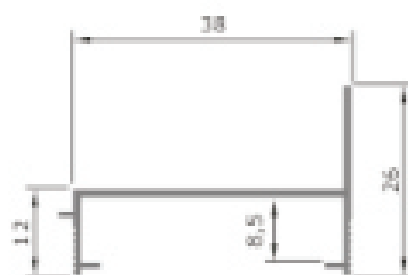

39-126

0,245 Kg/m

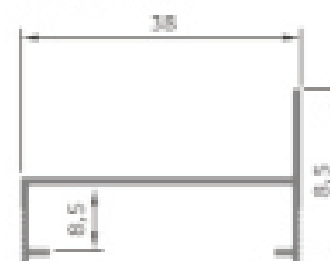

CM-060

0,279 Kg/m

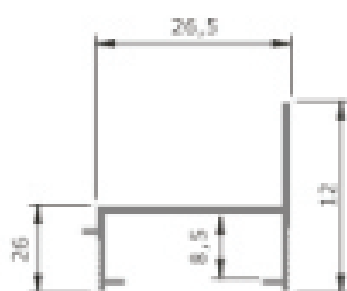

39-118

0,293 Kg/m

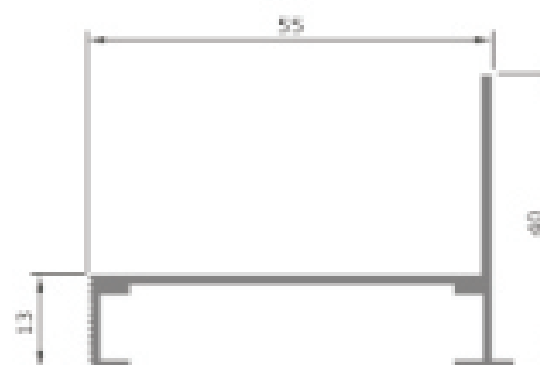

39-161

0,544 Kg/m



39-500
0,287 Kg/m

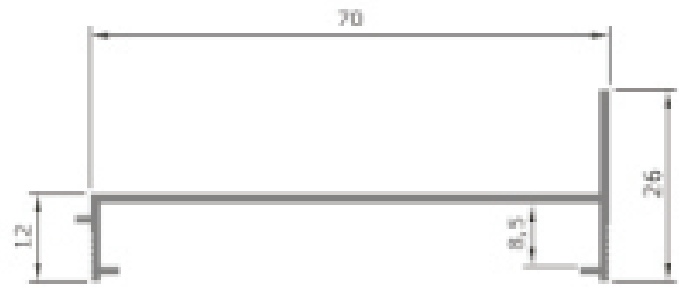

39-119
0,414 Kg/m

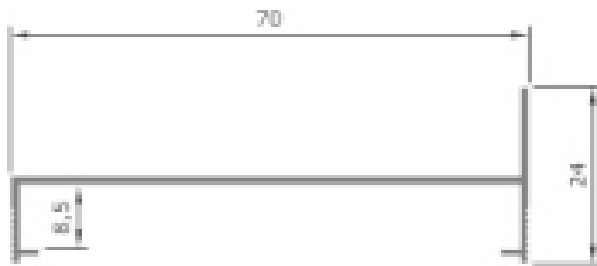

CM-096
0,394 Kg/m



39-341
0,391 Kg/m



ME-032
0,513 Kg/m

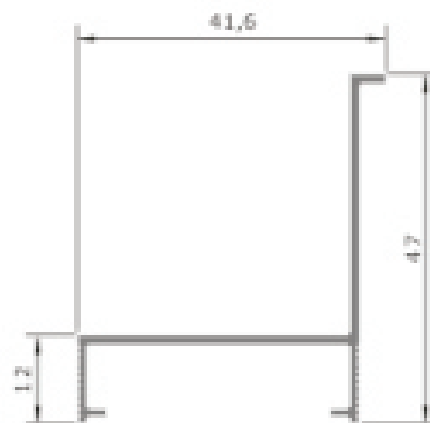

CM-098
0,377 Kg/m